



YOU DREAM, WE SHAPE!



**RAF & MARKET EKİPMANLARI
TEL VE TELDEN MAMÜL AKSESUARLAR
SHELF & STAND & SHOPFITTING
INDUSTRY**

**ÜRÜN KATALOĞU
PRODUCT CATALOGUE**

www.gunestel.com

HAKKIMIZDA

Kurulduğu ilk günden beri kalitede ve müşteri memnuniyetinde en yukarıda olmayı hedefleyerek bugün Türkiye'nin lider üreticilerinden biri olmayı başarmıştır.

Sektörün dinamik markalarından biri olan "GÜNEŞ TEL ÇEKME SANAYİ VE TİCARET A.Ş." başta soğuk çekilmiş parlak tel olmak üzere tüm tel, tel mamulleri ve yarı mamul sektöründe hizmet veren ülkemizin öncü firmasıdır. Merkezi ve fabrikası İstanbul'da bulunan firmanın üretim tesisleri, lojistik açıdan avantajlı olan İstanbul şehir merkezine ve Atatürk Havaalanı'na yaklaşık 38 km, en büyük deniz limanına 26 km ve konteynır limanına 30 km uzaklıktadır. Arnavutköy Hadımköy'de 20.000 m²'si kapalı olmak üzere toplam 30.000 m² alan üzerine kurulu bulunan tesisler, Türkiye'yi boydan boya geçen uluslararası E-5 ve TEM karayolu güzergâhındadır.

Yılda 15.000 tonun üzerinde demir işleme kapasitesine sahip olan GÜNEŞ TEL ÇEKME SANAYİ VE TİCARET A.Ş. 'nin 100 çalışanı bulunmaktadır. Çalışanların tümünün hedefi aynıdır: "Herhangi bir üretici değil, Türkiye'nin en iyi üreticisi olmak."

GÜNEŞ TEL ÇEKME SANAYİ VE TİCARET A.Ş.'nin üretiminde düşük, orta ve yüksek karbonlu soğuk çekilmiş tel, parlak soğuk çekilmiş tel, yaylık çelik tel, yağlı balya teli, bakır kaplı, galvaniz kaplı, fosfat kaplı tel, siyah ve parlak tavlı bağ teli, doğrultulmuş ve kesilmiş çubuk tel, taşlanmış ve polisajlanmış çubuk tel, elektrogalvanizli ve paslanmaz çubuk tel, vida teli, somun teli, cıvata teli, perçin teli, aksesuar teli, 3 ve 2 boyutlu CNC bükülmüş ve şekillendirilmiş tel, paslanmaz bükülmüş tel, punta kaynaklı hasır tel, dekoratif panel çit teli, aratavlı vida teli, saplama, gijon, U bolt, lama profil, yarım daire profil, kare profil, altıgen profil ve diğer özel profillere kadar uzanan, geniş bir ürün yelpazesi bulunmaktadır.

ABOUT US

"GUNES WIRE" is one of the dynamic brands most of the sectors offering services such as wire, wire products and semi finished wire products, mainly cold drawn bright wires.

The production facilities of the company, whose head office and factory are located in Istanbul, in Hadımköy is nearly 38 km away from Istanbul city center and Atatürk airport, which is advantageous in logistical terms, 26 km away from the biggest seaport and 30 km away from the container port. The facilities situated on an area of totally 30.000 m², 20.000 m² of which is indoors.

Over the last 40 years, our company has become one of the leading wire producers in Turkey. GUNES WIRE , which has a forging capacity of over 25.000 tons per year, includes 100 employees working hard to make company the best producer in all over the world.

In the production process of GUNES WIRE, a large range of products is offered including: Low, mild and high carbon steel wires, cold-drawn and bright drawn steel wires, high carbon industrial spring steel wires, copper, electrogalvanised, phosphated steel wires, black and bright annealed binding wires, oiled bailing wire, cut to length wire bars, sanded and polished rod wire bars, cold heading annealed screw wires, nut wires, bolt wires, rivet wires, wire accessories, 3- and 2-dimension cnc bended and shaped wires, welded wire assembly lines, stainless steel bended wires, electrogalvanised and coppered bended wires, semi finished wire products, spot welded wire meshes, multifence, grills decorative wire fences and panels, threaded rods, whitworth rods, u & v bolts, sheet profiles, cold drawn flat wire bars & coils, half-rounded profiles, square profiles, hexagonal profiles and other special profiles.

TEL KANCALAR / WIRE HOOKS

TAŞIYICI TEL DELİKLİ PANO TEKLİ ASKI KANCASI* SINGLE HOOK FOR GRIDS



Boy / Length (mm)	Tel Çapı / Wire Dia. (mm)	Ağırlık / Weight (kg/pcs)
150	4,0	0,037
200	4,0	0,042
300	4,0	0,052

TAŞIYICI TEL ÇİFTLİ DELİKLİ PANO ÇİFTLİ ASKI KANCASI* DOUBLE HOOK FOR GRIDS



Boy / Length (mm)	Tel Çapı / Wire Dia. (mm)	Ağırlık / Weight (kg/pcs)
150	4,0	0,060
200	4,0	0,070
300	4,0	0,090

50 mm'ye kadar bir delik yüksekliğine sahip ızgaralar için
For grids with a hole-height up to 50 mm.

DELİKLİ SACAYA GEÇEN TEKLİ ASKI KANCASI* SINGLE HOOK FOR PERFORATION BOARDS



Boy / Length (mm)	Tel Çapı / Wire Dia. (mm)	Aralık / Distance (mm)	Ağırlık / Weight (kg/pcs)
150	4,8	45	0,033
200	4,8	45	0,040
250	4,8	45	0,047
300	4,8	45	0,053
300	6,0	45	0,080
400	6,0	45	0,102

DELİKLİ SACAYA GEÇEN ETİKETLİ TEKLİ ASKI KANCASI* SINGLE HOOK FOR PERFORATION BOARDS FOR LABEL JACK



Boy / Length (mm)	Tel Çapı / Wire Dia. (mm)	Aralık / Distance (mm)	Ağırlık / Weight (kg/pcs)
200	4,8	45	0,046
300	4,8	45	0,060
400	4,8	45	0,074

* KROM VEYA ÇİNKO KAPLAMALI / CHROME PLATED OR ZINC PLATED

TEL KANCALAR / WIRE HOOKS

TAŞIYICI TEL DELİKLİ PANO ETİKETLİ* SINGLE HOOK FOR PERFORATION BOARDS WITH TOP LABEL HOLDER FOR LABEL JACKET



Boy / Length (mm)	Tel Çapı / Wire Dia. (mm)	Aralık / Distance (mm)	Ağırlık / Weight (kg/pcs)
200	4,8	45	0,074
300	4,8	45	0,088
300	6,0	45	0,128
300	8,0	45	0,186
400	6,0	45	0,165
400	8,0	45	0,239

ÇİFTLİ DÖNGÜ KANCA DELİKLİ PANO* DOUBLE LOOP HOOK FOR PERFORATION BOARDS



Boy / Length (mm)	Tel Çapı / Wire Dia. (mm)	Aralık / Distance (mm)	Ağırlık / Weight (kg/pcs)
120	3,0	25	0,020
160	3,0	25	0,024
200	3,0	25	0,029
300	4,0	25	0,072

TAŞIYICI TEL ÇİFTLİ DELİKLİ PANO* DOUBLE HOOK FOR PERFORATION BOARDS



Boy / Length (mm)	Tel Çapı / Wire Dia. (mm)	Aralık / Distance (mm)	Ağırlık / Weight (kg/pcs)
150	4,8	45	0,060
200	4,8	45	0,074
250	6,0	45	0,089
300	8,0	45	0,103
350	6,0	45	0,117
400	8,0	45	0,132

TAŞIYICI TEL ÇİFTLİ DELİKLİ PANO ETİKETLİ* DOUBLE HOOK FOR PERFORATION BOARDS WITH TOP LABEL HOLDER FOR LABEL JACKET



Boy / Length (mm)	Tel Çapı / Wire Dia. (mm)	Aralık / Distance (mm)	Ağırlık / Weight (kg/pcs)
200	4,8	45	0,111
300	4,8	45	0,154
400	6,0	45	0,266

* KROM VEYA ÇİNKO KAPLAMALI / CHROME PLATED OR ZINC PLATED

TEL KANCALAR / WIRE HOOKS

TAŞIYICI TEL TEKLİ SWİFEL KAPAKLI*

SINGLE HOOK FOR PERFORATION BOARDS WITH SWIFEL FLAP



Boy / Lenght (mm)	Tel Çapı / Wire Dia. (mm)	Aralık / Distance (mm)	Ağırlık / Weight (kg/pcs)
200	4,8	30	0,075
300	4,8	30	0,089

TAŞIYICI TEL ETİKETLİ SWİFEL KAPAKLI*

SINGLE HOOK FOR PERFORATION BOARDS WITH SWIFEL FLAP WITH TOP LABEL HOLDER FOR LABEL JACKET



Boy / Lenght (mm)	Tel Çapı / Wire Dia. (mm)	Aralık / Distance (mm)	Ağırlık / Weight (kg/pcs)
150	4,8	30	0,091
200	4,8	30	0,103
300	6,0	30	0,127

TAŞIYICI TEL ÇİFTLİ SWİFEL KAPAKLI*

DOUBLE HOOK FOR PERFORATION BOARDS WITH SWIFEL FLAP



Boy / Lenght (mm)	Tel Çapı / Wire Dia. (mm)	Aralık / Distance (mm)	Ağırlık / Weight (kg/pcs)
200	4,8	30	0,104
300	4,8	30	0,132

TAŞIYICI TEL ÇİFTLİ ETİKETLİ SWİFEL KAPAKLI*

DOUBLE HOOK FOR PERFORATION BOARDS WITH SWIFEL FLAP WITH TOP LABEL HOLDER FOR LABEL JACKET



Boy / Lenght (mm)	Tel Çapı / Wire Dia. (mm)	Aralık / Distance (mm)	Ağırlık / Weight (kg/pcs)
200	4,8	30	0,132
300	4,8	30	0,170

* KROM VEYA ÇİNKO KAPLAMALI / CHROME PLATED OR ZINC PLATED

TEL KANCALAR / WIRE HOOKS

TAŞIYICI TEL TEKLİ DÖRT PENÇELİ SACLI* SINGLE HOOK WITH FOR CLUTCHES



Boy / Length (mm)	Tel Çapı / Wire Dia. (mm)	Aralık / Distance (mm)	Ağırlık / Weight (kg/pcs)
200	7,0	25	0,091
300	7,0	25	0,122
400	8,0	25	0,192

TAŞIYICI TEL ÇİFTLİ DÖRT PENÇELİ SACLI* DOUBLE HOOK WITH FOR CLUTCHES



Boy / Length (mm)	Tel Çapı / Wire Dia. (mm)	Aralık / Distance (mm)	Ağırlık / Weight (kg/pcs)
200	4,8	25	0,103
300	4,8	25	0,131

TAŞIYICI TEL TEKLİ 15x30 POFİLE GEÇEN* SINGLE BAR HOOK SUITABLE FOR BAR REAR SUPPORT 15x30



Boy / Length (mm)	Tel Çapı / Wire Dia. (mm)	Ağırlık / Weight (kg/pcs)
200	6,0	0,095
300	6,0	0,117

TAŞIYICI TEL ÇİFTLİ 15x30 POFİLE GEÇEN* DOUBLE BAR HOOK SUITABLE FOR BAR REAR SUPPORT 15x30



Boy / Length (mm)	Tel Çapı / Wire Dia. (mm)	Ağırlık / Weight (kg/pcs)
200	4,8	0,117
300	4,8	0,145

* KROM VEYA ÇİNKO KAPLAMALI / CHROME PLATED OR ZINC PLATED

TEL KANCALAR / WIRE HOOKS

TAŞIYICI TEL ASKI ARKA DESTEKLİ 20 TEKLİ*

SINGLE BAR HOOK SUITABLE FOR BAR REAR SUPPORT 20



Boy / Lenght (mm)	Tel Çapı / Wire Dia. (mm)	Ağırlık / Weight (kg/pcs)
200	8,0	0,142
300	8,0	0,181
400	8,0	0,220

TAŞIYICI TEL ASKI ARKA DESTEKLİ 20 ETİKETLİ*

SINGLE BAR HOOK SUITABLE FOR BAR REAR SUPPORT 20 WITH TOP LABEL HOLDER FOR LABEL JACKET



Boy / Lenght (mm)	Tel Çapı / Wire Dia. (mm)	Ağırlık / Weight (kg/pcs)
200	8,0	0,181
300	8,0	0,235
400	8,0	0,288

TAŞIYICI TEL ASKI ARKA DESTEKLİ 27 TEKLİ*

SINGLE BAR HOOK SUITABLE FOR BAR REAR SUPPORT 27



Boy / Lenght (mm)	Tel Çapı / Wire Dia. (mm)	Ağırlık / Weight (kg/pcs)
300	8,0	0,187
400	8,0	0,227

TAŞIYICI TEL ASKI ARKA DESTEKLİ 27 ETİKETLİ*

SINGLE BAR HOOK SUITABLE FOR BAR REAR SUPPORT 27 WITH TOP LABEL HOLDER FOR LABEL JACKET



Boy / Lenght (mm)	Tel Çapı / Wire Dia. (mm)	Ağırlık / Weight (kg/pcs)
300	8,0	0,24
400	8,0	0,3

TEL KANCALAR / WIRE HOOKS

TAŞIYICI TEL ASKI ETİKETLİ AHŞAP KANALLI PANO*

SINGLE HOOK WITH FOR SLATWALL WITH TOP LABEL HOLDER FOR LABEL JACKET



Boy / Lenght (mm)	Tel Çapı / Wire Dia. (mm)	Ağırlık / Weight (kg/pcs)
150	4,8	0,101
200	4,8	0,115
250	4,8	0,130

TAŞIYICI TEL ASKI ÇİFTLİ AHŞAP KANALLI PANO*

DOUBLE HOOK FOR SLATWALL



Boy / Lenght (mm)	Tel Çapı / Wire Dia. (mm)	Ağırlık / Weight (kg/pcs)
150	4,0	0,079
200	4,0	0,089

TAŞIYICI TEL ASKI ÇİFTLİ ETİKETLİ AHŞAP KANALLI PANO*

DOUBLE HOOK FOR SLATWALL WITH TOP LABEL HOLDER FOR LABEL JACKET



Boy / Lenght (mm)	Tel Çapı / Wire Dia. (mm)	Ağırlık / Weight (kg/pcs)
150	4,0	0,100
200	4,0	0,120

SEPARATÖR TEL*

WIRE DIVIDER WITH STABILE WIRE

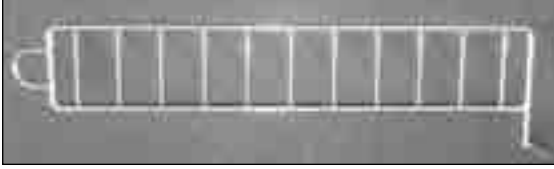

Boy / Length (mm)	Yükseklik / Height (mm)	Aralık / Distance (mm)	Ağırlık / Weight (kg/pcs)
340	60	20	0,110
440	60	20	0,137
540	60	20	0,164
640	60	20	0,192
340	60	30	0,102
440	60	30	0,126
540	60	30	0,150

SEPARATÖR TEL*

WIRE DIVIDER

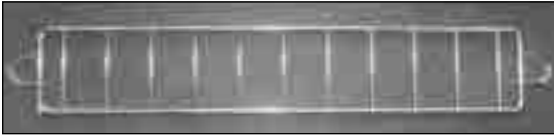

Boy / Length (mm)	Yükseklik / Height (mm)	Aralık / Distance (mm)	Ağırlık / Weight (kg/pcs)
340	60	20	0,110
440	60	20	0,137
540	60	20	0,164
440	60	30	0,126
540	60	30	0,150

SEPARATÖR TEL BÖLME*

WIRE DIVIDER WITH STABILE WIRE WITH SLANTING

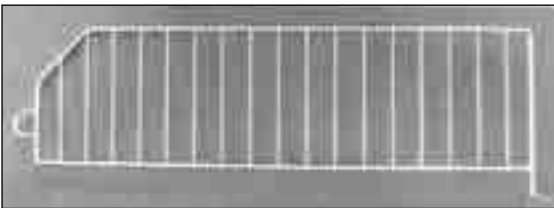

Boy / Length (mm)	Yükseklik / Height (mm)	Aralık / Distance (mm)	Ağırlık / Weight (kg/pcs)
340	120	20	0,140
440	120	20	0,175
540	120	20	0,210
640	120	20	0,245
440	150	30	0,171
540	150	30	0,206

SEPARATÖR TEL ÖN AYRAÇ*

FRONT LATTICE

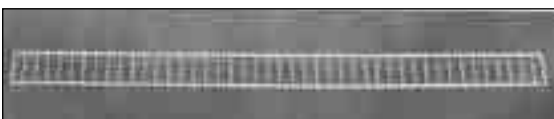

Boy / Length (mm)	Yükseklik / Height (mm)	Aralık / Distance (mm)	Ağırlık / Weight (kg/pcs)
990	80	30	0,360
1320	80	30	0,479
990	170	30	0,460
1320	170	30	0,600

AKSESUARLAR / ACCESSORIES*

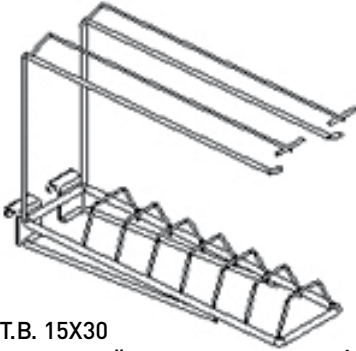

T.B. 15X30
L: 300 (4'LÜ), 400 (6'Lİ), 500 (8'Lİ)
TAŞIYICI FİNCAN TABAK

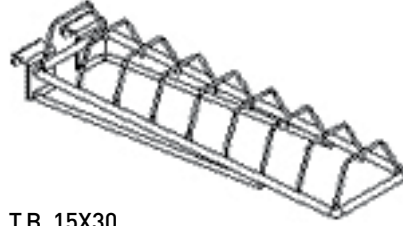

T.B. 15X30
L: 300 (6'Lİ), 400 (8'Lİ), 500 (10'LU)
TAŞIYICI FIRIN TEPŞİSİ

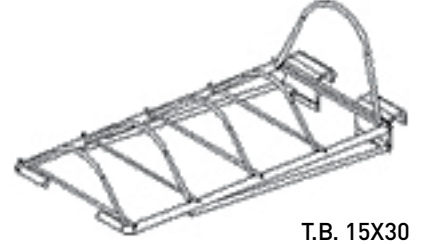

T.B. 15X30
L: 300 (3'LÜ), 400 (4'LÜ), 500 (5'Lİ)
TAŞIYICI TABAKLIK

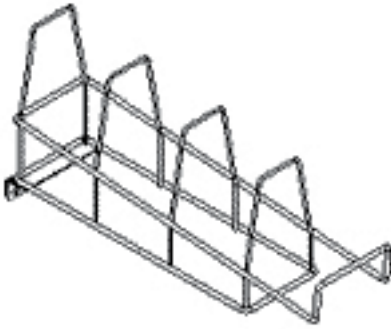

L: 300 (3'LÜ), 400 (4'LÜ), 500 (5'Lİ), 600 (6'Lİ)
TAŞIYICI TEL TABAKLIK - RAF ÜSTÜ

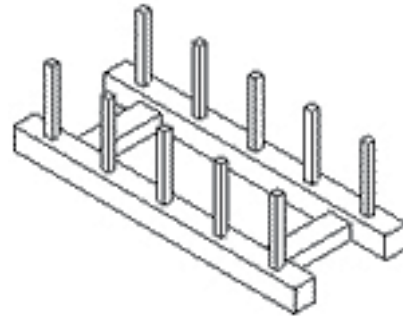

L: 300 (3'LÜ), 400 (4'LÜ), 500 (5'Lİ), 600 (6'Lİ)
TAŞIYICI AHŞAP TABAKLIK - RAF ÜSTÜ

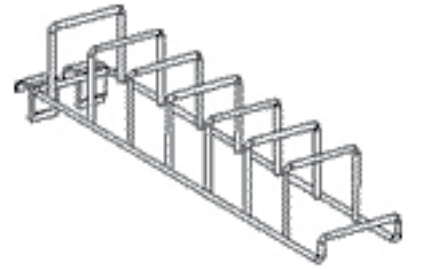

T.B. 15X30
L: 300, 400, 500
TAŞIYICI TABAKLIK

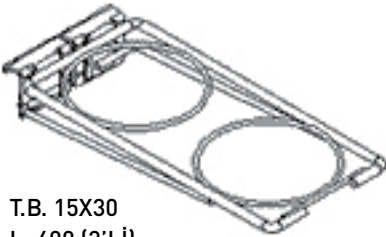

T.B. 15X30
L: 400 (2'Lİ)
TAŞIYICI KASELİK



T.B. 15X30 ETİKETLİ
L: 430
TAŞIYICI FIRIN TABAK

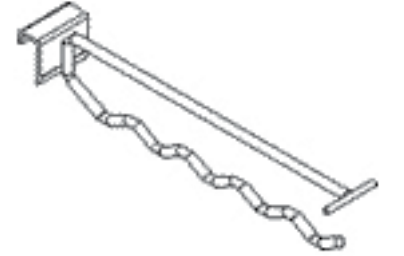

T.B. 30X15
L: 300, 400, 500
TAŞIYICI TAVALIK

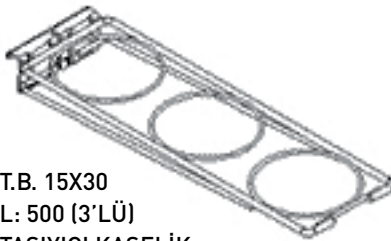

T.B. 15X30
L: 500 (3'LÜ)
TAŞIYICI KASELİK

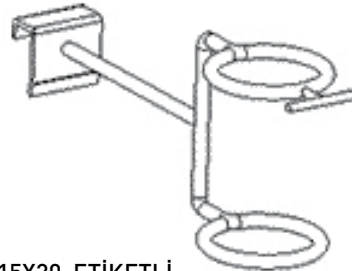

T.B. 15X30 ETİKETLİ
L: 250

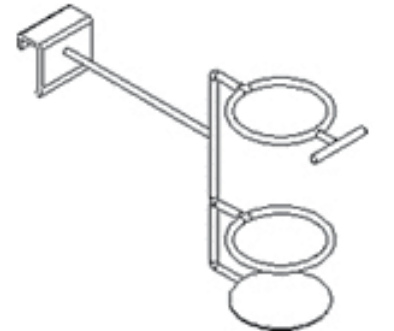

T.B. 15X30 ETİKETLİ
L: 250

AKSESUARLAR / ACCESSORIES

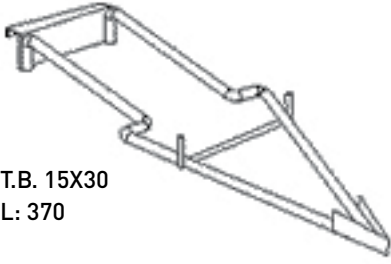

T.B. 15X30
L: 370

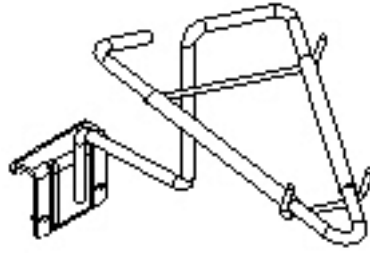

T.B. 15X30
L: 190

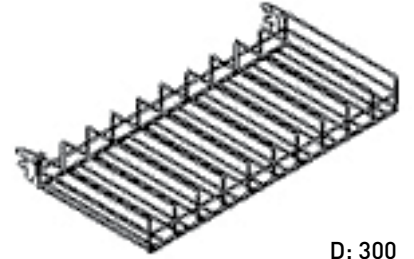

D: 300
L: 500, 700, 900, 1000, 1250, 1330

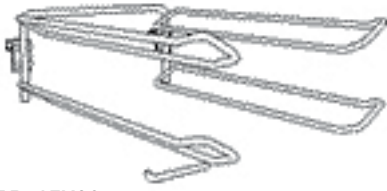

T.B. 15X30
D: 400 | L: 130, 190, 230, 260



YEDEK
T.B. 15X30
D: 400 | L: 130, 190, 230, 260

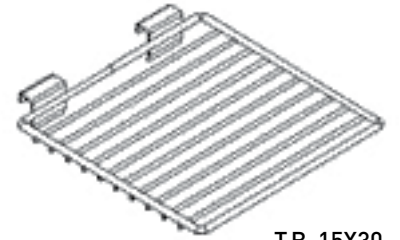

T.B. 15X30
D: 300 | L: 200, 250, 300

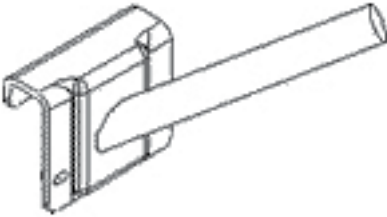

T.B. 15X30
L: SAĞ, SOL

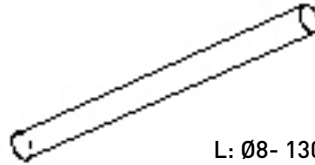

L: Ø8- 130

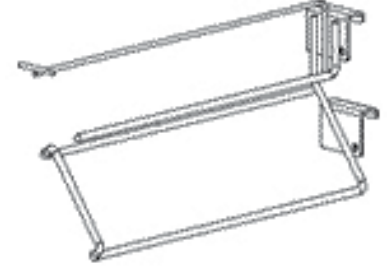

T.B. 15X30 ETİKETLİ
L: 300, 400, 50

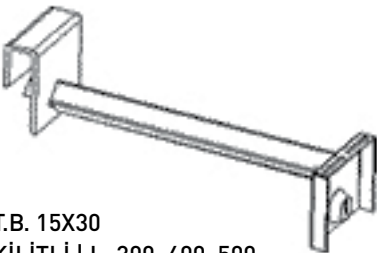

T.B. 15X30
KİLİTLİ | L: 300, 400, 500



T.B. 15X30 ETİKETLİ
L: 300, 400, 500

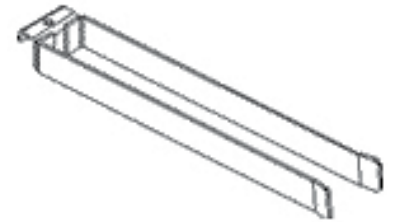

SAPLI ÜRÜN
T.B. 15X30 | L: 300, 400, 500

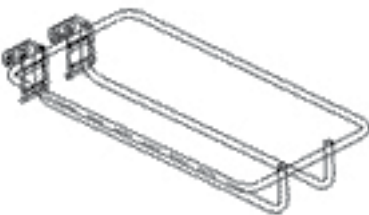

T.B. 15X30
L: 140, 230 | L: 300, 400, 500

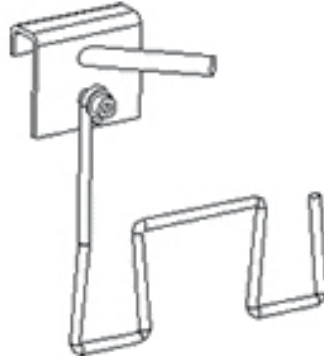

T.B. 15X30

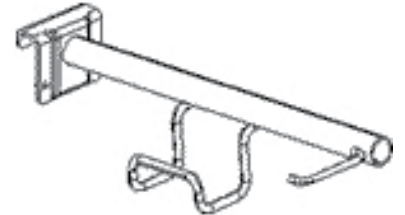

T.B. 15X30
SAĞ, SOL - ETİKETLİ L: 300

TEL AKSESUARLAR / WIRE ACCESSORIES*

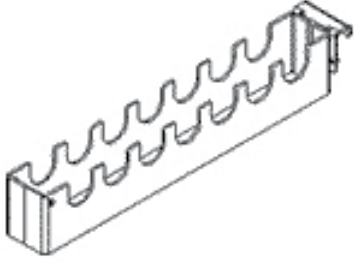

T.B. 15X30
L: 300, 400, 500

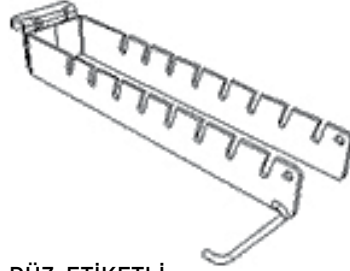

DÜZ ETİKETLİ
T.B. 15X30 | L: 300, 400, 500

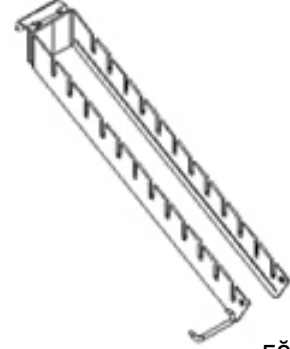

EĞİK ETİKETLİ
T.B. 15X30 | L: 300, 400, 500

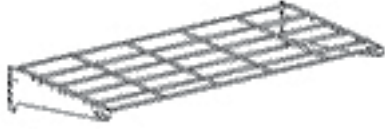

PERİOD 200X100
D: 500 | L: 500, 700, 900, 1000, 1250, 1330

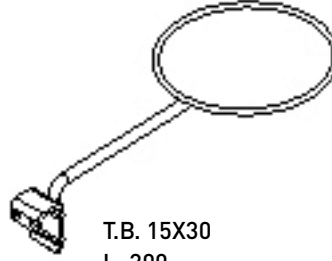

T.B. 15X30
L: 300

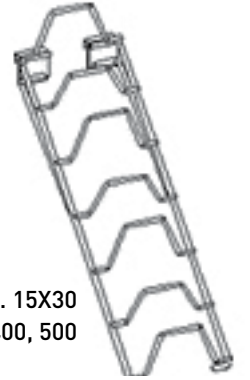

T.B. 15X30
L: 300, 400, 500

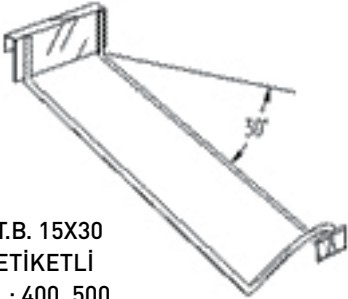

T.B. 15X30
ETİKETLİ
L: 400, 500

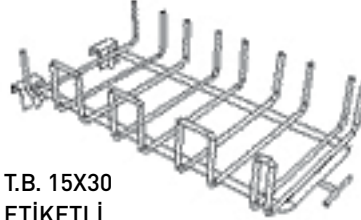

T.B. 15X30
ETİKETLİ
L: 300, 400, 500

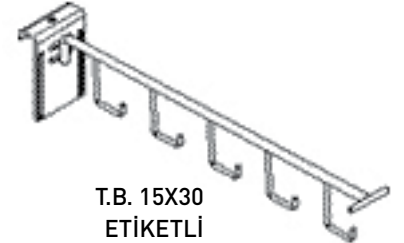

T.B. 15X30
ETİKETLİ
L: 300, 400, 500



L: 1000 (4'LÜ), 1250 (5'Lİ), 1330 (6'Lİ)



H: 1815, 2015, 2215
W: 700
L: 400, 500, 600



H: 1815, 2015, 2215
W: 1000
L: 400, 500, 600

TEL SEPETLER / WIRE BASKETS*

KATLANIR TEL SEPET FOLDING WIRE CONTAINER BASKET

Ergonomic Foldable
Leveled Depth
Nickel Chrome / Zinc Coated

Ergonomik Katlanır Yapı
Kademeli Derinlik Ayarı
Nikel Krom / Çinko Kaplama

H: 570 mm
D: 750 mm
L: 800 mm

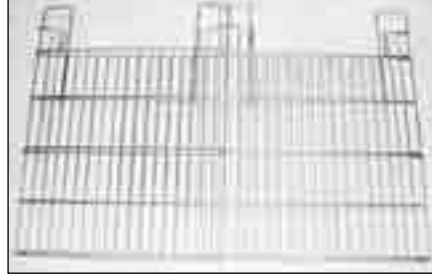

RAF SEPET* WIRE BASKET



H: 200 | D: 300 | L: 500, 700, 900, 1000, 1250, 1330
H: 200 | D: 400 | L: 500, 700, 900, 1000, 1250, 1330
H: 200 | D: 500 | L: 500, 700, 900, 1000, 1250, 1330
H: 200 | D: 600 | L: 500, 700, 900, 1000, 1250, 1330

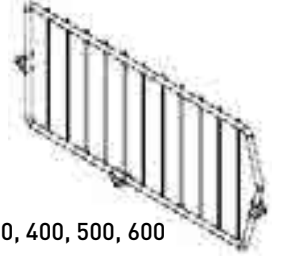

H: 200 | L: 300, 400, 500, 600

TIRNAKLI SEPET* WIRE BASKET



H: 180 | D: 300 | L: 500, 700, 900, 1000, 1250, 1330
H: 180 | D: 400 | L: 500, 700, 900, 1000, 1250, 1330
H: 180 | D: 500 | L: 500, 700, 900, 1000, 1250, 1330
H: 180 | D: 600 | L: 500, 700, 900, 1000, 1250, 1330

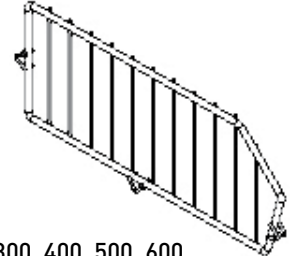

H: 180 | L: 300, 400, 500, 600

TEL-ECO SEPE WIRE BASKET



H: 250 | D: 300 | L: 500, 700, 900, 1000, 1250, 1330
H: 250 | D: 400 | L: 500, 700, 900, 1000, 1250, 1330
H: 250 | D: 500 | L: 500, 700, 900, 1000, 1250, 1330
H: 250 | D: 600 | L: 500, 700, 900, 1000, 1250, 1330

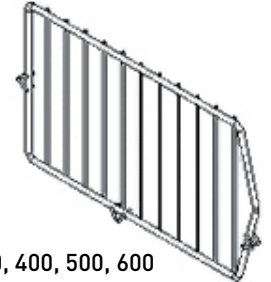

H: 250 | L: 300, 400, 500, 600

TEL MEGA SEPE WIRE BASKET



H: 500 | D: 300 | L: 1000, 1250, 1330
H: 500 | D: 400 | L: 1000, 1250, 1330
H: 500 | D: 500 | L: 1000, 1250, 1330
H: 500 | D: 600 | L: 1000, 1250, 1330



H: 500 | L: 300, 400, 500, 600

* KROM VEYA ÇİNKO KAPLAMALI / CHROME PLATED OR ZINC PLATED

EV EŞYALARI ASKI APARATLARI*
HANGERS FOR HOUSEHOLD ARTICLES

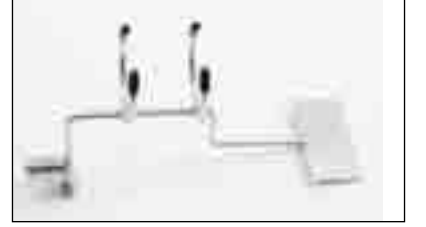

KIYAFET ASKI TELLERİ*
DRESS HANGER WIRES

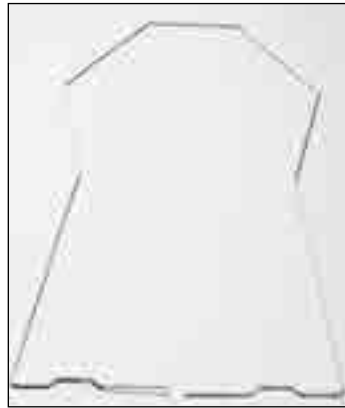
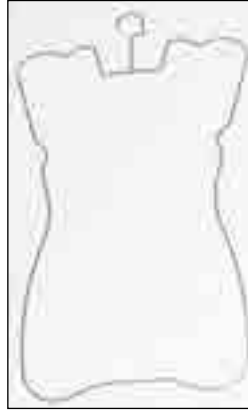

BOYAHANE ASKI KANCASI*
DYEHOUSE HANGER

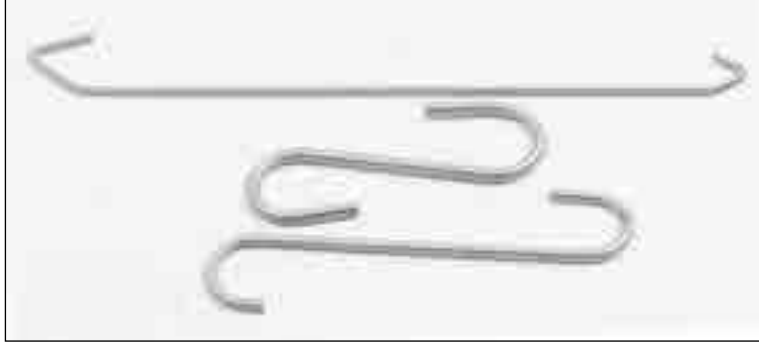

TOPLUK & ŞAPKALIK ASKI TELLERİ*
HANGERS FOR BALLS & HATS

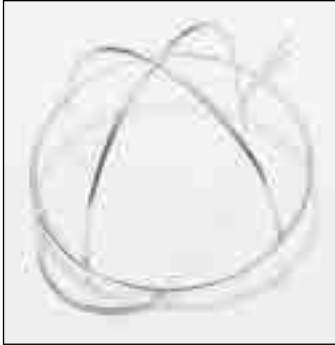



YOU DREAM, WE SHAPE!

Factory adress / Fabrika adresi

Atatürk Sanayi Bölgesi
İhsangazi Sokak No: 48
Hadımköy - İstanbul / Türkiye

Tel : +90 212 671 35 00 (pbx)
+90 212 612 03 30
Fax : +90 212 671 35 08
+90 212 612 03 39

Billing adress / Fatura adresi

Terazidere Mah. Güneş Cad.
Sinan Sokak No: 17
34160 Bayrampaşa - İstanbul / Türkiye

Tel : +90 212 612 03 30
Fax : +90 212 612 52 32

info@gunestel.com

www.gunestel.com

